



## DESCRIPTION

The Heritage Series of vertical exhaust roof units has been designed for use in ducted exhaust applications. It features a high performance centrifugal fan and removable windband which makes cleaning and maintenance easy.

There are 8 sizes in the series extending from 315 to 710mm diameter.

## Typical Applications

Can exhaust air at normal to high temperatures for applications such as commercial kitchens and bakeries. Can also exhaust toxic or explosive gases in industrial applications.

## Features

- Durable galvanised steel construction with powder coated finish.
- Designed to handle clean air, grease laden air, toxic noxious and explosive gases as well as handling air at elevated temperatures.
- Motor is mounted out of the airstream.
- Motors to suit hazardous conditions can be fitted to some models.
- Special finishes, such as epoxy coating can be supplied.
- Available in a range of speeds to suit specific applications.
- Windband can be easily removed to allow easy access for cleaning and maintenance.
- Can be mounted at angles up to 15°.

## Construction

Cowls are of galvanised steel with a powder-coated finish. Impellers are a backward-curved centrifugal design.

Windband is fitted with quick-release toggle clamps to facilitate cleaning and maintenance.

Stainless steel construction is an optional extra.

## Motors

Type - standard TEFC squirrel cage induction motors.

Electricity supply - single or three-phase to suit a wide range of voltages and frequencies.

Bearings - sealed-for-life, ball.

Speed-controllable using variable speed drives.

Multi-speed motors can be supplied.

Motors to meet Ex e, Ex nA and Ex tD

Standards can be fitted to some models.

See pages O-3/7 for details on these motors.

## Internal thermal Protection

Thermistors can be fitted on request

## Testing

Air flow to ISO 5801: 2007

Noise tests to ISO3744: 2010

## Wiring Diagram

See pages N-6/7 diagrams DD 1, 2, 3, 7, 8.

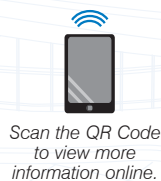

## ANCILLARY EQUIPMENT

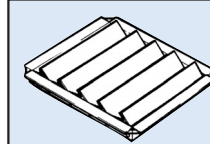

CBD - Backdraft shutter  
Ref. J-2

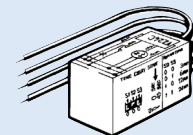

VZ Run-on timer  
Ref. M-14



Variable speed drives  
Ref. M-8/13

## NOISE DATA

### Model

Model		In-Duct Spectrum Corrections, dB*							
CHD..		63	125	250	500	1k	2k	4k	8k
CHE..		63	125	250	500	1k	2k	4k	8k
314	Inlet	35	29	21	18	10	10	8	2
316	Inlet	34	26	22	18	12	12	6	0
354	Inlet	28	26	22	19	10	12	11	1
356	Inlet	33	25	22	19	14	8	3	0
404	Inlet	28	26	21	18	11	12	12	5
406	Inlet	33	28	22	19	14	10	7	3
454	Inlet	27	25	20	17	11	12	12	8
456	Inlet	31	30	21	18	13	11	9	5
504	Inlet	26	26	21	15	12	12	12	9
506	Inlet	30	29	22	16	12	10	8	6
564	Inlet	26	27	23	14	13	12	12	10
566	Inlet	29	29	23	15	12	10	8	7
568	Inlet	30	27	22	15	15	11	11	6
634	Inlet	24	28	24	12	13	11	12	10
636	Inlet	28	29	24	14	12	10	8	8
638	Inlet	28	27	23	14	14	9	10	6
716	Inlet	28	29	24	14	12	10	8	8
718	Inlet	28	27	23	14	14	9	10	6

\* Add the In-Duct Spectrum Corrections to the closest dB(A) level shown on the fan curve to obtain the In-Duct Sound Power Level on the Inlet Side of the unit.

## SUGGESTED SPECIFICATION

The Heritage Series of vertical exhaust centrifugal roof ventilators shall be as designed and manufactured by Fantech Pty Ltd.

The cowl shall be of powder coated galvanised steel unless specified otherwise. Impellers shall be backward-curved centrifugal design and driven by standard TEFC motors unless specified otherwise.

The windband shall incorporate quick-release toggle clamps to provide easy access for cleaning and maintenance.

All models shall be fully tested as a complete assembled unit to ISO5801: 2007 for air flow and to ISO3744: 2010 for noise.

## HOW TO ORDER

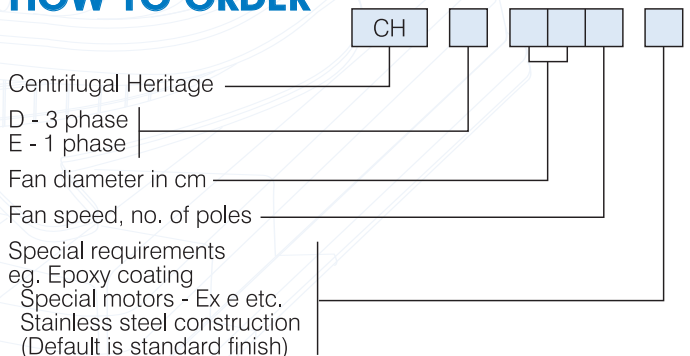

## TECHNICAL DATA

Model	Nom. Speed CHE.. rev/sec	Avg. dB(A) @ 3m		Motor kW	
		Low Air Flow	High Air Flow	CHE.. 1ph.	CHD.. 3 ph.
314	24	48	49	0.37	0.55
316	16	41	43	-	0.37
354	24	53	52	0.55	0.55
356	16	44	44	-	0.37
404	24	57	55	0.55	0.55
406	16	45	45	-	0.37
454	24	60	58	0.75	0.55
456	16	48	47	-	0.37
504	24	63	62	1.5	1.1
506	16	51	51	-	0.37
564	24	66	66	-	2.2
566	16	55	55	-	0.55
568	12	45	48	-	0.37
634	24	70	71	-	4.0
636	16	61	59	-	1.1
638	12	47	51	-	0.55
716	16	64	62	-	2.2
718	12	49	54	-	1.1

Amperages for motors can be obtained at the time of order or from the motor nameplate.

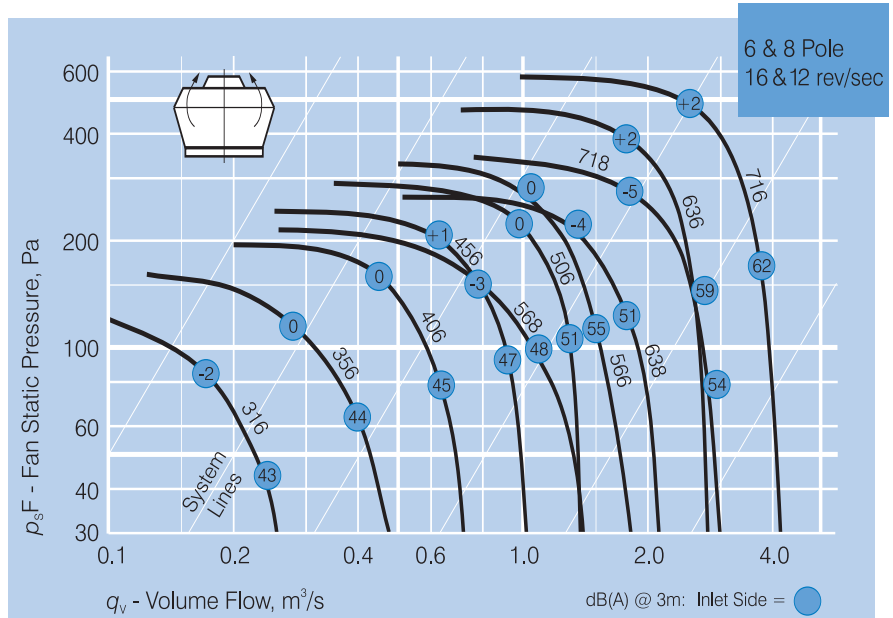
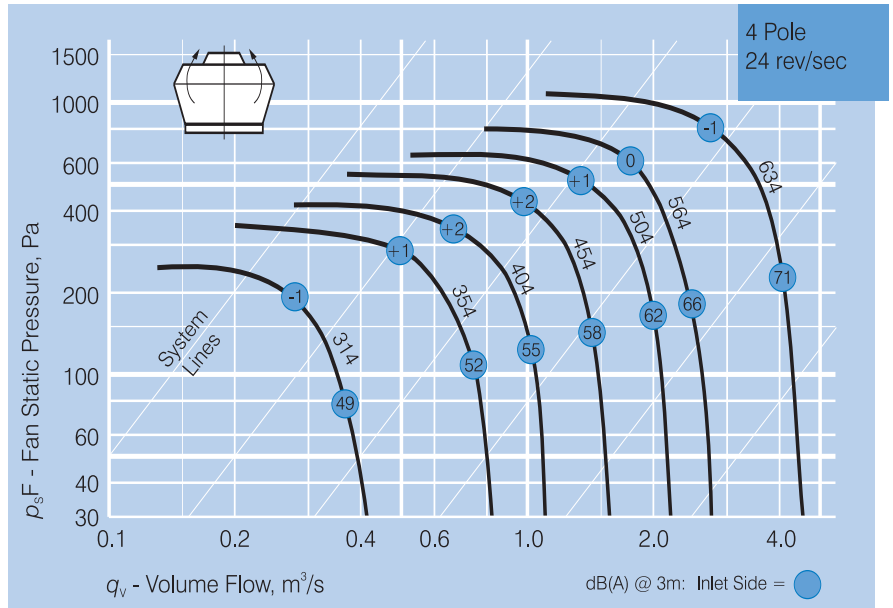

## DIMENSIONS

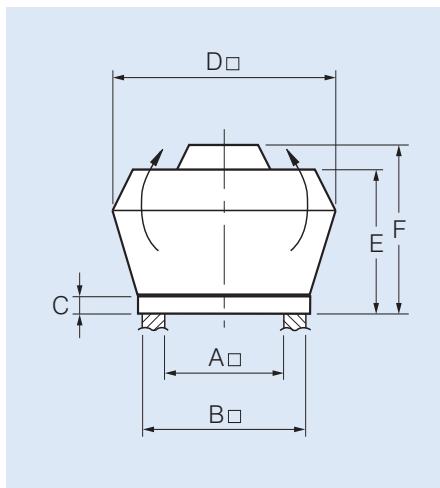

Model Number CHD.. 3ph. CHE.. 1ph.	Dimensions, mm						Approx.* weight kg.	Approx volume m³
	A	B	C	D	E	F max.		
314/6	310	410	50	520	310	540	16	0.1
354/6	400	500	50	665	420	550	26	0.22
404/6	400	500	50	665	420	570	26	0.22
454/6	620	720	60	900	540	790	49	0.5
504/6	620	720	60	900	540	820	57/51	0.5
564/6/8#	620	720	60	900	540	850	65/56/55	0.5
634/6/8#	710	810	60	1160	665	965	97/78/74	1.05
716/8#	710	810	60	1160	655	1000	95/83	1.05

# Three-phase motors only.

\* Unit weights depend on the make of motor used. If critical this should be referred to our sales department at time of order.